



PMSTR-4001 Version 2  
January 25, 2024

# PMSTR-4000 (V2) Plant Master Installation and Operation



**508A**  
**Enclosed Industrial**  
**Control Panel**

## DESCRIPTION

The PMSTR-4000 Plant Master provides central control of a steam or hot water system for up to eight NXF4000 or PPC4000 control units. The connection to each control uses standard Modbus wiring to a dedicated sequencing bus.

The PMSTR-4000 offers increased savings during operation by considering how many units to operate as a system, rather than allowing each unit to calculate an independent demand. Automatic lead rotation promotes even operating hours over time. All operating parameters and setpoints are adjustable so operation can be fine-tuned to the installation.

Options such as outdoor temperature setpoint reset, warm weather shutdown, time-of-day schedule functionality and pump control with feedback alarms provide versatility allowing installation in many different types of systems.

The PMSTR-4000 can be used in conjunction with any compatible NXF4000 or PPC4000 user interface. Local functionality such as thermal shock and hot standby are available and can be enabled at each control.



Watchdog timers in the NXF4000 and PPC4000 controls ensure that operation will revert to local control if there is a communication issue with the PMSTR-4000. This prevents any situation where there is a lack of output for the process.

The PMSTR-4000 has UL508A listing for enclosed industrial control panels. The enclosure is IP66 (NEMA 4X) rated.

The PMSTR-4000 is configured using the 7" touchscreen. Communication is available to a PLC/SCADA/BMS using Modbus TCP/IP and/or Modbus RTU via RS-232, RS-422 or RS-485. All operating information is available to read, and many control functions are available to write as well. All communication parameters are configurable.

See Fireeye bulletin *NXF-4100* for additional information on configuration and operation of the NXF4000 and PPC4000 controls. This bulletin only covers installation and operation of the PMSTR-4000 Plant Master.



---

## TABLE OF CONTENTS

DESCRIPTION.....	1
TECHNICAL DATA .....	4
ORDERING INFORMATION.....	5
SAFETY ADVICE.....	6
MOUNTING.....	6
Dimensional Diagram.....	7
WIRING.....	8
Terminals.....	8
Fuses .....	9
Modbus Wiring .....	10
Wiring Diagram .....	11
SENSOR INSTALLATION.....	13
Pressure Sensors.....	13
Temperature Sensors.....	13
NXF4000 OR PPC4000 SETUP .....	14
Sequencing Enable .....	14
Hot Standby .....	14
Thermal Shock.....	14
FEATURE DESCRIPTIONS .....	15
Load Control.....	15
Automatic Lead Rotation.....	15
Outdoor Temperature Reset and Warm Weather Shutdown .....	15
Remote Operation.....	16
Setpoint Priority.....	16
Pump Control .....	16
Time-of-day Schedule .....	17
INTERFACE.....	18
Navigation Icons.....	18
Home.....	19
Passcode .....	20
Setup.....	21
Timer Status.....	22
Setpoints .....	23
Setting Real-Time Clock.....	24
Trend.....	24
Data Log.....	25
OPTION PARAMETERS .....	26
Option Group 1 – General.....	26
Option Group 2 – Sensor .....	26
Option Group 3 – Aux Input .....	26
Option Group 4 – Pump .....	27
Option Group 5 – Timers.....	27



---

Option Group 6 – Outside Air .....	27
Option Group 7 – Setpoints .....	28
Option Group 8 – Setpoint 1 Skips .....	28
Option Group 9 – Setpoint 2 Skips .....	29
Option Group 10 – Setpoint 1 Order .....	29
Option Group 11 – Setpoint 2 Order .....	30
Option Group 12 – Commands .....	30
Option Group 13 – Network IP Address .....	30
Option Group 14 – Network Subnet Mask .....	30
Option Group 15 – Network Default Gateway .....	31
Option Group 16 – Modbus RTU .....	31
Option Group 17 – Sunday Schedule .....	32
Option Group 18 – Monday Schedule .....	32
Option Group 19 – Tuesday Schedule .....	33
Option Group 20 – Wednesday Schedule .....	33
Option Group 21 – Thursday Schedule .....	34
Option Group 22 – Friday Schedule .....	34
Option Group 23 – Saturday Schedule .....	35
TIMER STATUS .....	36
MODBUS .....	38
Modbus Connection .....	38
Modbus Mapping .....	39
CERTIFICATIONS .....	43
NOTICE .....	44
WARRANTIES, EXCLUSIVE REMEDIES, AND LIMITATION OF DAMAGES .....	44



---

## TECHNICAL DATA

Screen type:	TFT, 4-wire analog resistive
Resolution:	800 x 480
Diagonal screen area:	177.8mm (7 in.)
Backlight:	LED rated at 20,000 hours at 25°C
Interface method to NXCESO2:	Modbus RTU via RS-485
Nominal voltage:	100VAC-240VAC (45Hz-65Hz)
Nominal power consumption:	124.3VA
Internal power supply maximum output:	96W (24VDC)
Relay output ratings:	230VAC/2A, pilot duty only
Analog input resolution:	16-bit
Analog output resolution:	12-bit
Operating temperature range:	0°C to 60°C (32°F to 140°F)
Operating humidity:	10% to 95%, non-condensing
Storage temperature range:	-20°C to 85°C (-4°F to 185°F)
Shock during operation:	25g acceleration for 11ms
Degree of protection:	IP66 (NEMA 4X), indoor use only (not UV stabilized)
Unit dimensions:	270mm x 370mm (10.64 in. x 14.59 in.)
Unit dimensions depth:	151mm (5.92 in.)
Weight:	4.76kg (10.5 lb.)



## ORDERING INFORMATION

Plant Master		Bulletin
PMSTR-4000	Plant master for use with NXF4000 and PPC4000 efficiency controls.	PMSTR-4001
Pressure Sensors		Bulletin
BLPS-15	Pressure transducer, 0mBar to 1030mBar (0psi to 15psi), 4-20mA output linear to pressure, ¼" NPT mount.	BLZPTS-1
BLPS-30	Pressure transducer, 0mBar to 2070mBar (0psi to 30psi), 4-20mA output linear to pressure, ¼" NPT mount.	
BLPS-200	Pressure transducer, 0Bar to 13.8Bar (0psi to 200psi), 4-20mA output linear to pressure, ¼" NPT mount.	
BLPS-300	Pressure transducer, 0Bar to 20.7Bar (0psi to 300psi), 4-20mA output linear to pressure, ¼" NPT mount.	
Temperature Sensors		Bulletin
TS350-2	Temperature transmitter Pt100, 0°C to 176°C (32°F to 350°F), 4-20mA output linear to temperature, ½" NPT stainless thermowell with 51 mm (2 inch) insertion depth.	BLZPTS-1
TS350-4	Temperature transmitter Pt100, 0°C to 176°C (32°F to 350°F), 4-20mA output linear to temperature, ½" NPT stainless thermowell with 102 mm (4 inch) insertion depth.	
TS350-8	Temperature transmitter Pt100, 0°C to 176°C (32°F to 350°F), 4-20mA output linear to temperature, ½" NPT stainless thermowell with 204 mm (8 inch) insertion depth.	
TS752-2	Temperature transmitter Pt100, 0°C to 400°C (32°F to 752°F), 4-20mA output linear to temperature, ½" NPT stainless thermowell with 51 mm (2 inch) insertion depth.	
TS752-4	Temperature transmitter Pt100, 0°C to 400°C (32°F to 752°F), 4-20mA output linear to temperature, ½" NPT stainless thermowell with 102 mm (4 inch) insertion depth.	
TS752-8	Temperature transmitter Pt100, 0°C to 400°C (32°F to 752°F), 4-20mA output linear to temperature, ½" NPT stainless thermowell with 204 mm (8 inch) insertion depth.	
Outdoor Temperature Sensor		Bulletin
FXIATS-140	Outdoor air temperature sensor, -40°C to 60°C (-40°F to 140°F), 4-20mA.	FXIATS-1

---

## SAFETY ADVICE

The PMSTR-4000 Plant Master provides centralized control of the call for heat and firing rate commands for each connected device. The PMSTR-4000 does not provide any flame safety control. Ensure that all proper limits are installed and that wiring methods follow used for connected equipment follow all applicable codes.



**WARNING: Never rely on the PMSTR-4000 for any safety shutdown functions. This is because the PMSTR-4000 is connected using the sequencing bus, which is designed to revert the control back to running in local mode upon a loss of communication.**

A common example of a safety device that should not be wired to the PMSTR-4000 is an emergency shutdown switch. Emergency shutdown switches should be properly wired into each individual appliance to ensure that they will all properly shutdown from their power source or limit string when needed.

## MOUNTING

The PMSTR-4000 enclosure is designed for mounting indoors as the ABS poly blend of the enclosure is not UV stabilized. The enclosure has four mounting bosses that are designed for connecting to the provided mounting clips using M5 x 0.8mm bolts. These mounting clips can be mounted in any orientation that works best.



*Mounting clip boss*



*Mounting clip fastened to boss*

## Dimensional Diagram

The following diagram shows the footprint with the mounting clips attached and oriented in an up/down arrangement.

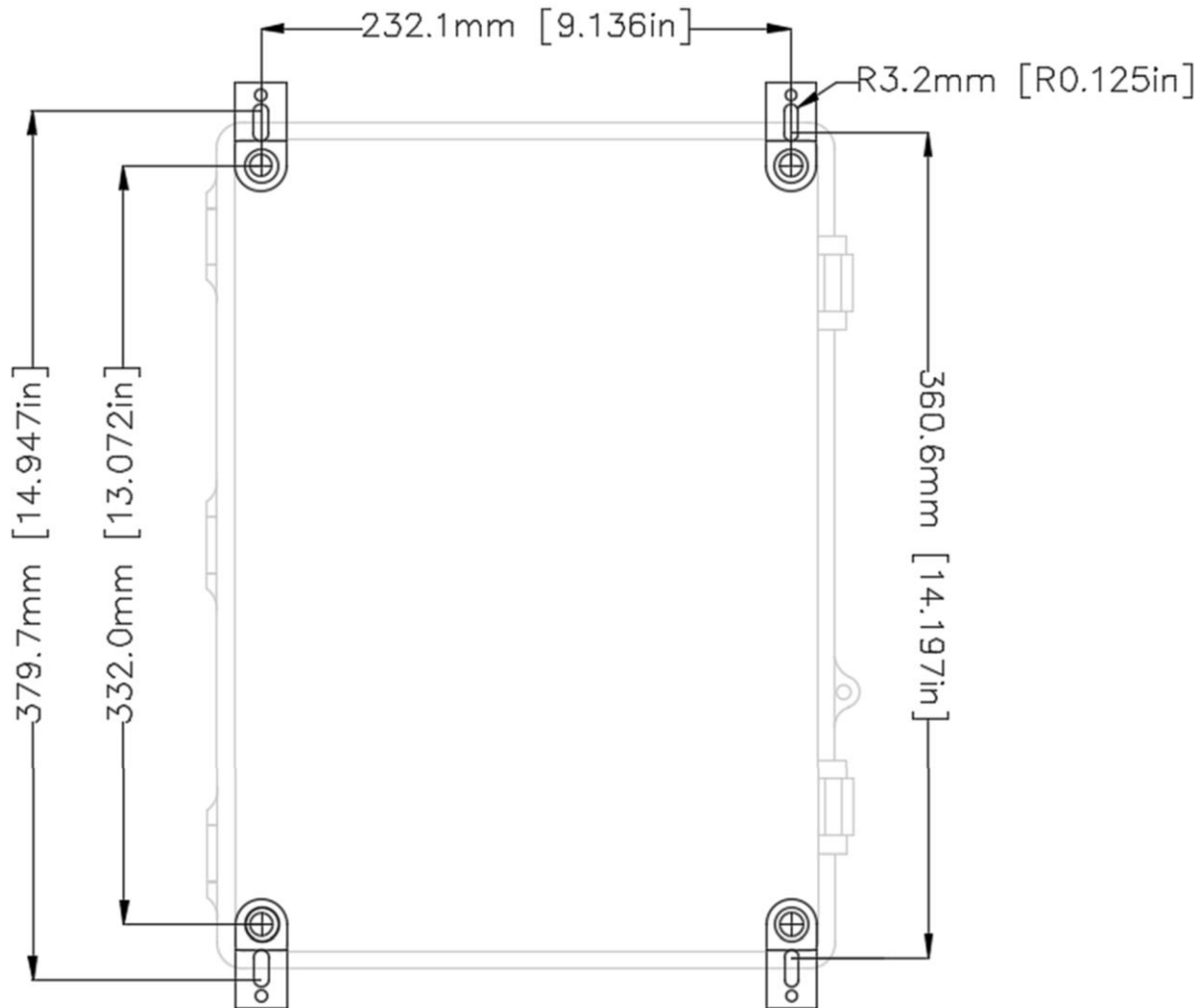



## WIRING

All conduit entry points should be drilled from the bottom of the enclosure. Ensure that no internal components can be damaged in the process. Also make sure that any fittings used will comply with the desired IP or NEMA rating as the IP66 or NEMA 4X ratings only apply before any penetrations are made. The rating after penetrations depends on the rating of the connectors.

Be sure to connect the ground connection first to eliminate any ESD (electrostatic discharge) potential.



**WARNING: Do not penetrate the top of the PMSTR-4000 enclosure when wiring. Doing so may result in debris entering the internal devices.**

## Terminals

Terminal	Type	Description	Notes
L1	Power In	Line voltage input 120VAC (50Hz/60Hz) Line voltage input 230VAC (50Hz/60Hz)	Input range 100VAC-240VAC nominal, 45Hz-65Hz
L2	Power In	Neutral input 120VAC (50Hz/60Hz) Line voltage input 230VAC (50Hz/60Hz)	
G	Ground	Incoming earth ground to back panel	Connected to back panel
A+	Modbus	Modbus A to devices on sequencing bus	Use twisted pair cable
B-	Modbus	Modbus B to devices on sequencing bus	Use twisted pair cable
DC+	Power	24VDC+ to sensors	BLPS-, TS350- or TS752- connect between DC+ and S1
S1	Analog In	4-20mA from temperature/pressure sensor	
S2	Analog In	4-20mA from outdoor temperature or remote setpoint	FXIATS-140 connects between DC+ and S2
DC-	Common	24VDC- to sensors	Remote setpoint connects between S2 and DC-
G	Ground	Earth ground for sensor shielding	Connected to back panel
AV	Analog Out	0-10VDC output for system load	Represents 0% to 100%
AC	Analog Out	4-20mA output for system load	
DC-	Common	24VDC- to sensors	Common from power supply
DC+	Power	24VDC+ to pump feedback inputs	Current sensor, flow switch or differential pressure switch connects between DC+ and PR1...PR4
PR1	Digital In	Pump feedback for unit 1	
PR2	Digital In	Pump feedback for unit 2	
PR3	Digital In	Pump feedback for unit 3	
PR4	Digital In	Pump feedback for unit 4	Current sensor, flow switch or differential pressure switch connects between DC+ and PR5...PR8
DC+	Power	24VDC+ to pump feedback inputs	
PR5	Digital In	Pump feedback for unit 5	
PR6	Digital In	Pump feedback for unit 6	
PR7	Digital In	Pump feedback for unit 7	
PR8	Digital In	Pump feedback for unit 8	





Terminal	Type	Description	Notes
DC+	Power	24VDC+ to other inputs	Connect remote disable or use setpoint 2 inputs between DC+ and RD/SP to activate function
RD	Digital In	Remote disable input	
SP	Digital In	Use setpoint 2 input	
Q	Digital Out	24VDC+ when panel is online	Use to remotely monitor panel health
DC-	Common	24VDC- to for status output	
EN1	Relay Out	Pump enable for unit 1	Connect voltage for pump starters to C1 relay outputs to EN1...EN4 to enable pumps
EN2	Relay Out	Pump enable for unit 2	
EN3	Relay Out	Pump enable for unit 3	
EN4	Relay Out	Pump enable for unit 4	
C1	Relay Common	Common for pump enables 1-4	
EN5	Relay Out	Pump enable for unit 5	Connect voltage for pump starters to C2 relay outputs to EN5...EN8 to enable pumps
EN6	Relay Out	Pump enable for unit 6	
EN7	Relay Out	Pump enable for unit 7	
EN8	Relay Out	Pump enable for unit 8	
C2	Relay Common	Common for pump enables 5-8	

## Fuses

There is one internal fuse that protects the 24VDC power supply. The fuse is marked FU5 and is a Bussmann FNQ-R-1 or equivalent.

## Modbus Wiring

Up to eight NXF4000 and PPC4000 units can be mixed on the sequencing network.

The network uses the Modbus RTU protocol via RS-485. The controls should be wired in a point-to-point (Daisy-chain) topology as per the RS-485 specification. The terminals for the Modbus sequencing network are P12.3 (A+) and P12.4 (B-). Connect ground/drain to earth ground to avoid communication errors.

If there are communication issues or long wiring runs are made, termination resistance may be required at the first and last device. This is a resistor with a value between  $100\Omega$  and  $200\Omega$  that is placed across the Modbus A+ and Modbus B- terminals.

See Fireye document *NXF-4100* for additional details on wiring to the NXF4000 or PPC4000 control.

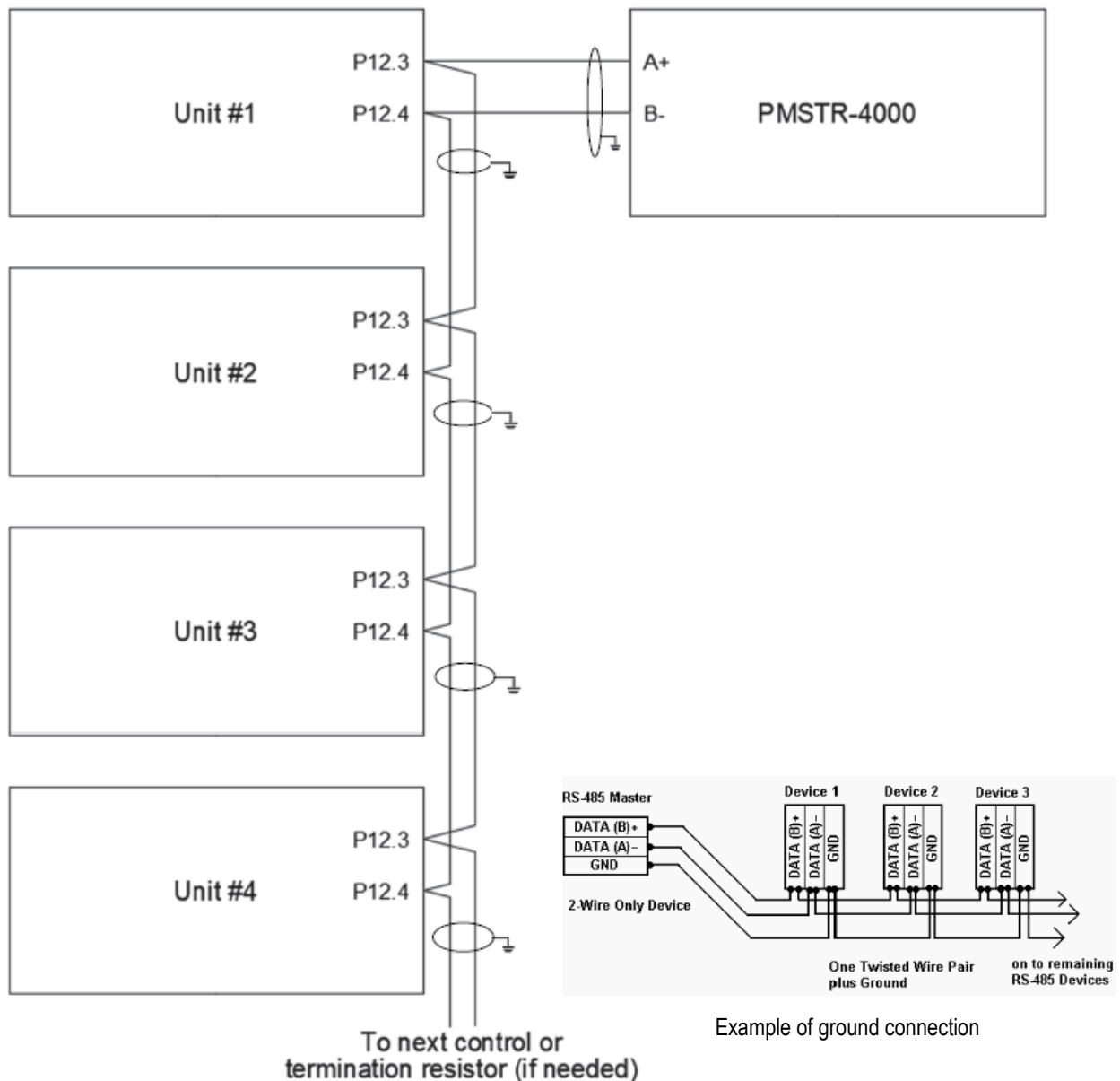

**NOTE:** Connect communication ground wire to earth ground at each 4000 control and Plant Master.

## Wiring Diagram

The following is the as-built wiring diagram for the PMSTR-4000 (split to two pages):

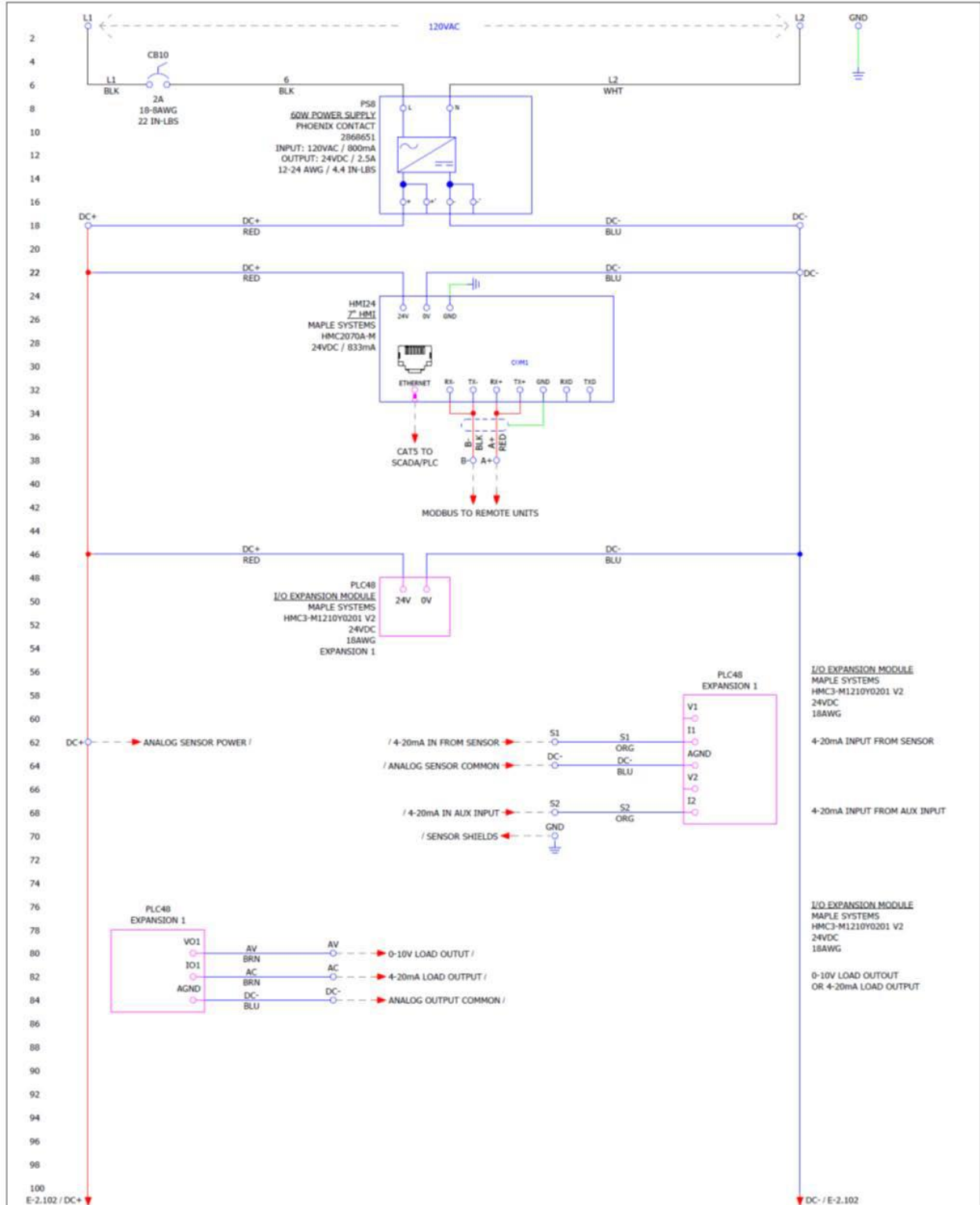

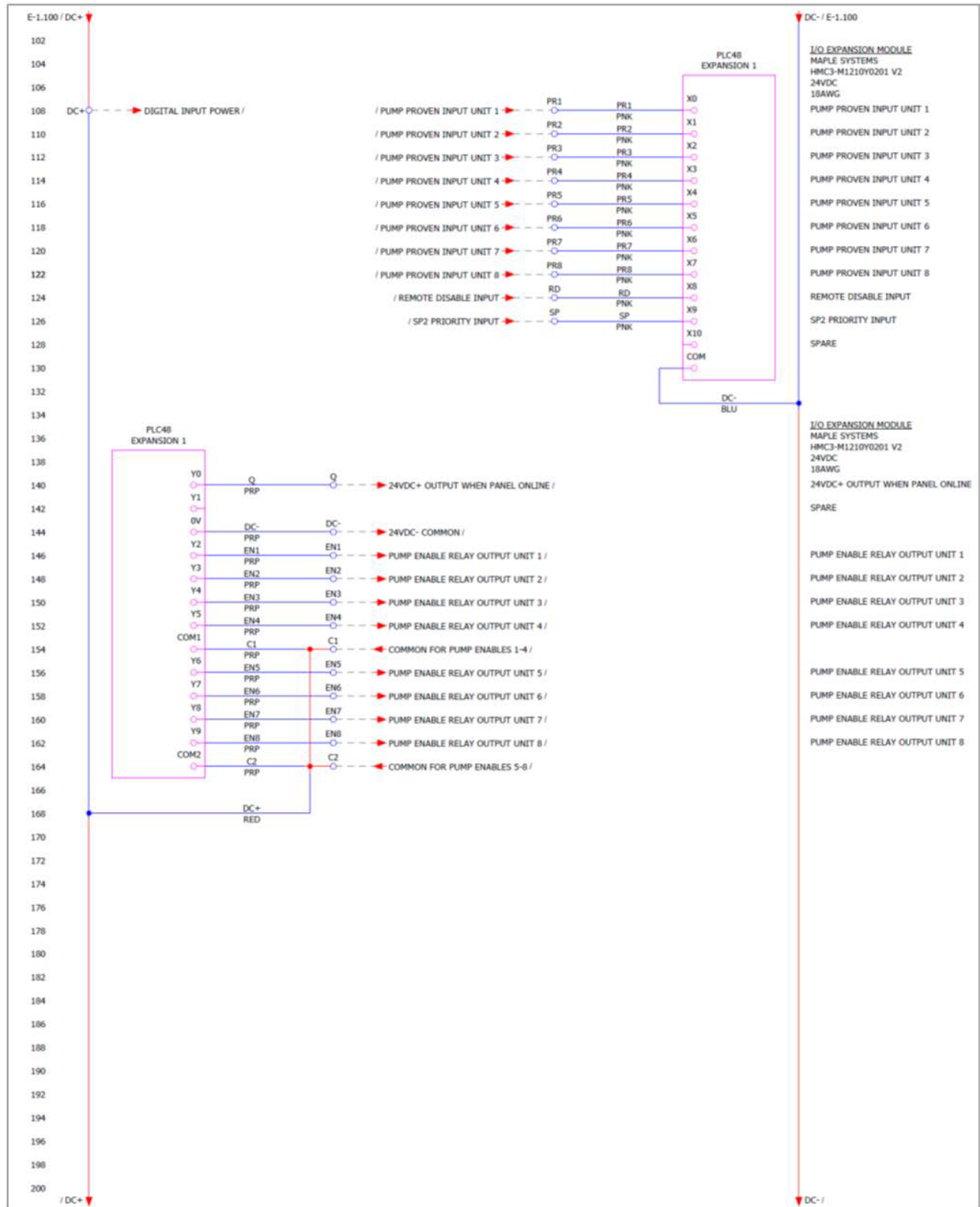



## SENSOR INSTALLATION

Note: See bulletin *BLZPTS-1* for more detail on installation and wiring of these sensors.

### Pressure Sensors

The BLPS series pressure transmitters convert operating pressure into a 4-20mA signal in a scale that can be read by the PMSTR-4000.

The BLPS series pressure transmitters have a 1/4" NPT male thread for mounting. Choose a mounting location in the steam header with accessibility for servicing. Always use a 180° syphon (shown in figure below) with a 1/4" NPT coupler when mounting the pressure transmitter to the steam header. The syphon will fill with water and provide a barrier between the direct temperature of the steam and the transmitter. Without the syphon, the transmitter will be subject to temperature outside of the design limits and may fail. In lieu of using a syphon, the transmitter may also be connected to an engineered "controls tree" if provided by the equipment manufacturer. The design of the controls tree has the piping drop and rise before controls are mounted, also providing a location for a water barrier to form.



### Temperature Sensors

Select either a TS350- or TS752- temperature sensor depending upon the maximum temperature needed for the application. For most hot water heating applications, a TS350- is appropriate. Select an insertion depth that will put the sensing probe in the center of the flow. For most hot water applications, a TS350-2 is the best sensor to use.

The loop supply sensor should be installed in the primary loop, not in the secondary loop. This is because the system pump should be running all the time to provide the circulation needed for the temperature sensor. If the sensor is in the secondary loop, an option does exist to have the lead unit pump operate continuously to provide circulation for the temperature sensor. The best location in the primary loop to locate the temperature sensor is right after the heat comes back in from the secondary loop.

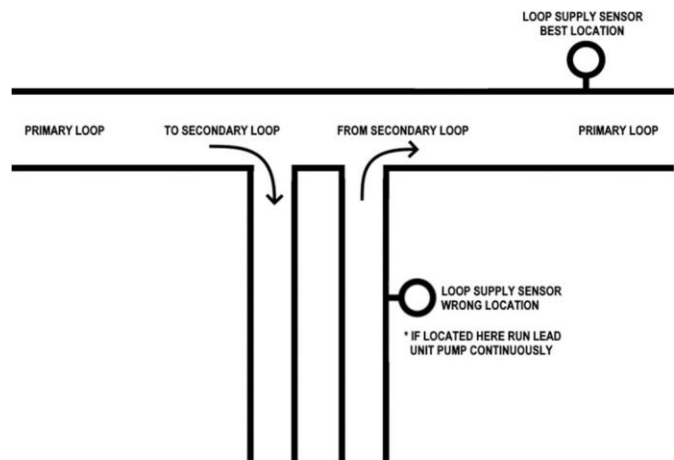



## NXF4000 OR PPC4000 SETUP

### Sequencing Enable

Sequencing must be enabled on the NXF4000 or PPC4000. Using sequencing does not affect the ability to use Modbus from the user port or the ability to use any available user interface. The only caveat is that both the user Modbus interface and the sequencing Modbus interface share the same node address. The node address when connected to the PMSTR-4000 must be the same as the connected unit number (i.e., Unit 1 is connected to the control with node address 1).

From the user interface, set up the following options to enable sequencing:

COMMUNICATION SETUP → UNIT ADDRESS	1...8
KEYPAD SETUP → LEAD LAG KEY	UNUSED
SEQUENCING SETUP → MASTER SLCT	COMMS
SEQUENCING SETUP → SLAVES AVAILABLE	0

This is fundamentally the same as configuring the peer-to-peer sequencing network except that the ability to select any unit as the master control is inhibited.

Messages will be displayed on the screen to indicate the command from the PMSTR-4000 while online.

If the unit is commanded off, the message will read SEQUENCED OFF. If the unit is commanded on, the message will read SEQUENCED SLAVE. If the internal stat is keeping the unit off because the temperature or pressure is above the unit's local setpoint, the message NO CALL FOR HEAT will be displayed in addition to SEQUENCED SLAVE. The unit will also be marked as offline so another unit can assume the lead or lag role if needed.

STANDBY	s01
SEQUENCED OFF	
SETPOINT 1	100psi
PCV VALUE	90psi
AUTO	s16
FLAME STRENGTH	100
SEQUENCED SLAVE	
PCV VALUE	90psi

### Hot Standby

Hot standby can be enabled on any of the connected units by connecting a temperature sensor to sensor input 2 and selecting STANDBY as the type. The settings for setpoint 2 will be the standby parameters. Whenever the unit is commanded to be off by the

lead/lag system, it will still be enabled by the hot standby function to maintain the standby temperature. See *NXF-4100* for additional detail on this function, including wiring and configuration.

AUTO	s16
FLAME STRENGTH	100
STANDBY WATER	304°F
PCV VALUE	97psi

### Thermal Shock

Thermal shock protection can be enabled on any of the connected units by connecting a temperature sensor to sensor input 2 and configuring thermal shock using the THERMAL SHOCK SETUP menu. The thermal shock routine selected will be administered before the unit can modulate. See *NXF-4100* for additional detail on this function, including wiring and configuration.



---

## FEATURE DESCRIPTIONS

### Load Control

A centralized temperature or pressure sensor is compared against a setpoint to create a system load demand. This system load is what is used to determine when to enable and disable lag units.

Each individual NXF4000 or PPC4000 can be either online or offline relative to the system. For a control to be online, sequencing must be properly activated on the control with a unique node address assigned. In addition, each control has a virtual HAND-OFF-AUTO switch provided on the interface that must be set to AUTO for a control to be online. The HAND mode allows the control to be intentionally placed offline so that it can be controlled using the locally installed sensor (independent operation). Lastly, a unit will also be deemed offline if it is locked out or the burner is turned off. For recycle limit string, tie terminal P15.4 to any digital input, USE > Burner Control > Action > AND, to be deemed offline.

If at least one unit is online, there can be a system setpoint assigned. If there are no units online, there will not be any system load. There can be multiple setpoint sources based on the options chosen, and the source will be shown on the interface. The system load is calculated in percent based upon the number of units that are online. For example, if there are four units, every 25% of load would represent one unit at full output (high fire). When calculating the individual firing rates for enabled units, the system load is shared. With four units online and a system load of 20%, if only one unit is firing it would have a firing rate of 80%. Once a second unit is firing, the firing rate for each would be 40%.

Staging for the lag units is done using start and stop percentages as well as delay timers for each. Using the default start percentage of 80% as an example, the first lag unit start timer will begin once the lead unit firing rate exceeds 80%. If this condition remains true for the entire timing period, the lag unit will start. This same method is used for each lag unit, except that the firing rate compared to is always the previously enabled unit. The lag units will be disabled when their own firing rates fall below the stop percentage for the duration of the stop timer. Using the default stop percentage of 30% as an example, the first lag unit stop timer would begin once the first lag unit firing rate dropped below 30%. If the condition remained true for the entire timing period, the lag unit will then stop.

### Automatic Lead Rotation

Automatic lead rotation occurs after the current lead unit has reached the setting (in hours) for automatic rotation. The accumulated time only counts when the lead unit is running. If the lead unit changes status to offline at any point, the first lag will assume the lead position temporarily until the original lead is placed online again. The original lead will get credit for the hours run so any change in online status should be addressed as quickly as possible. With automatic lead rotation, the operating hours of all connected units should be close to even over time. It is possible to disable the automatic lead rotation and manually select the lead unit as well.

When the lead unit changes, there is an overlap period where both units will run. This is typically set so that the new lead unit has time to go through the startup sequence, to eliminate any gaps in operation.

### Outdoor Temperature Reset and Warm Weather Shutdown

If an outdoor temperature sensor is connected to the aux analog input, it is possible to enter parameters for an outdoor temperature-based setpoint reset. The range of desired setpoints as well as the outdoor start and design temperatures can be modified as needed. When the outdoor temperature reading is valid, the setpoint will be periodically recalculated. If the outdoor temperature sensor reading becomes invalid, the system will revert to using the locally entered Setpoint 1.



---

When connecting an outdoor temperature sensor, there is also a parameter for shutting the system down when the outdoor temperature exceeds a setpoint. This is known as warm weather shutdown. This value can be adjusted as needed.

## Remote Operation

A remote disable signal as well as a remote setpoint can be used either hardwired, or via Modbus. The remote disable digital input is always available, but the remote setpoint analog input is only available when not using the outdoor temperature sensor. The Modbus remote disable and remote setpoint are always available for use and have priority over all other setpoint sources except for Setpoint 2 when it is set to have priority status.

## Setpoint Priority

There are two local setpoints available that can be used, determined by the state of the *Use Setpoint 2* digital input. When this input is off, Setpoint 1 will be the local setpoint, including any lead/lag options specific to Setpoint 1. When the input is on, Setpoint 2 will be the local setpoint, including any lead/lag options specific to Setpoint 2. Additionally, there is an option for Setpoint 2 that can give it priority over all other setpoints. This can be useful if Setpoint 2 is attached to a function such as domestic hot water (DHW) priority.

The hierarchy of the setpoints is shown below from lowest to highest:

1. Setpoint 1 or Setpoint 2 (if Setpoint 2 does not have priority option set)
2. Outdoor Temperature Reset (uses Setpoint 1 or Setpoint 2 if reading is not valid)
3. Remote Analog
4. Remote Modbus
5. Setpoint 2 (if Setpoint 2 has priority option set)

## Pump Control

If this option is enabled, a pump output will be provided for each unit. When a unit starts, the pump output is enabled and the unit itself is delayed for a set period known as the start delay. This start delay gives time for the pump to circulate before the unit starts. When the unit shuts down, the pump will continue to run for the preset off delay period, which is adjustable. This also allows any latent heat to circulate before the pump shuts off.

There is also an option to connect pump feedback to digital inputs. When enabled, the status of the pump monitoring device will be shown on the interface. The pump monitoring device is typically a current sensor, but it can also be a mechanical flow switch, pressure switch, motor starter or VFD contact as well. It is also possible with an option to enable a pump alarm, which is triggered if the feedback is not received within a set allowed amount of time. If a pump alarm is created, the unit will be marked offline until the pump alarm is resolved.

Pump control is primarily designed for use with primary/secondary systems. If the system is primary only, isolation valves can also be connected to the pump outputs. Isolation valve proof-of-status can optionally be connected to the pump feedback.





---

## Time-of-day Schedule













A real-time clock (RTC) is provided to allow setting an enable schedule. There is one event that can be entered for each day of the week, with a start time and end time. An action is chosen for the time that is within the range entered, and an action is chosen for the time outside of the range entered. The actions can be to enable the system using the normal setpoint, enable the system using Setpoint 2, or to disable the system. If used to enable the system with Setpoint 2, Setpoint 2 will effectively become the unoccupied setpoint while the normal setpoint (typically Setpoint 1) will effectively become the occupied setpoint.

## INTERFACE

The touchscreen is used for configuration and monitoring of data.

### Navigation Icons

Navigation icons appear at the bottom of each screen. Some icons will appear on each screen while others only appear on certain screens and may have screen-specific functions.

	<b>POWER</b>	Displays virtual HAND-OFF-AUTO switch panel for selected unit
	<b>HOME</b>	Displays the HOME screen
	<b>SETPOINTS</b>	Displays the SETPOINTS screen (may redirect to PASSCODE entry)
	<b>SETUP</b>	Displays the SETUP screen (may redirect to PASSCODE entry)
	<b>TREND</b>	Displays the TREND screen
	<b>RESET</b>	<b>HOME:</b> Resets a pump alarm (if pump alarms are used) <b>SETPOINTS:</b> Resets auto rotation counter
	<b>PREVIOUS</b>	<b>HOME:</b> Switches between units 1-4 to units 5-8 <b>SETUP:</b> Displays previous groups of options
	<b>NEXT</b>	<b>HOME:</b> Switches between units 1-4 to units 5-8 <b>SETUP:</b> Displays next groups of options
	<b>TIMER</b>	Displays TIMER STATUS screen
	<b>CLOCK</b>	Displays real-time clock setting panel
	<b>DOWNLOAD</b>	Downloads displayed trend data to USB drive
	<b>ENTER</b>	Tests entered passcode

## Home

The first screen that appears after power-up is the HOME screen.

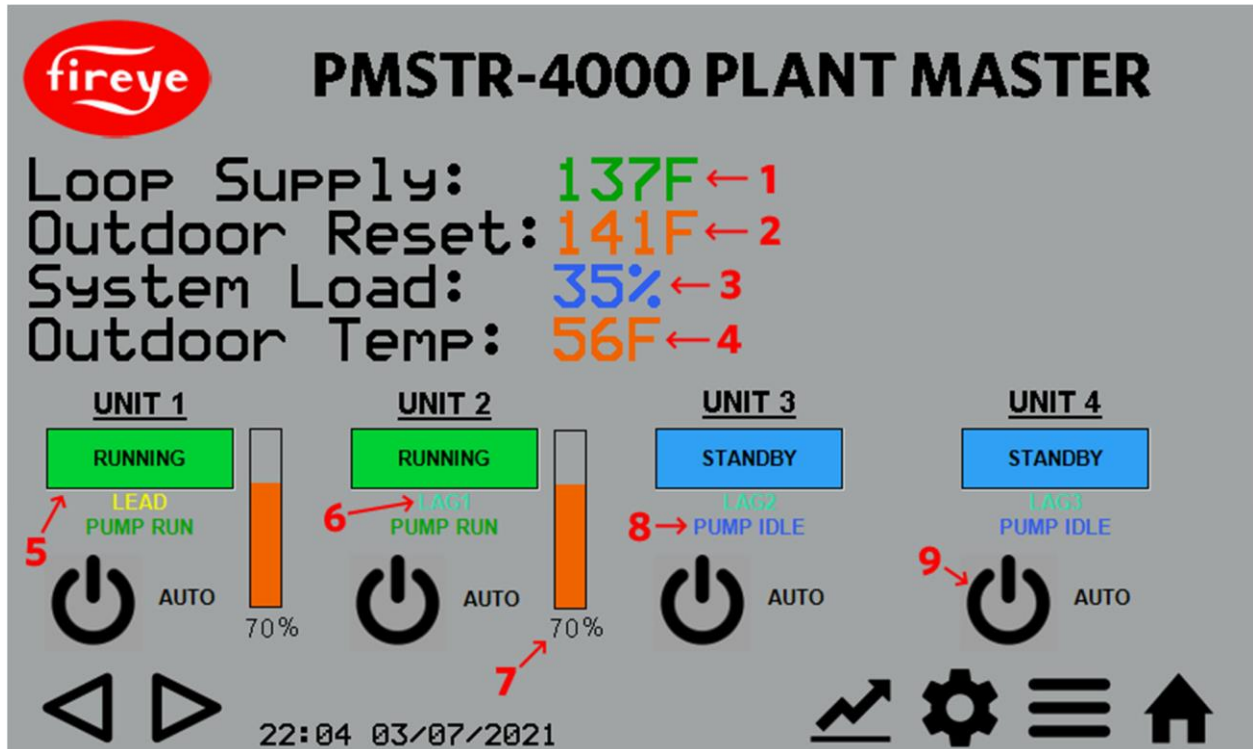

This screen displays all the operating information, as well as providing navigation access to other screens.

Only data that is configured will appear on the HOME screen. For example, the outdoor temperature will not even be shown if the option is not set (option group 2).

Each unit has a status panel that shows the current online status, lead/lag designation, pump status (if optioned), firing rate bar graph and virtual HAND-OFF-AUTO switch. The HOME screen will show up to four units, if the system is configured to control more than four units (option 1.0), navigation buttons will be shown to see the status panels for units 5+.

The date and time as set in the real-time clock are also shown.

Data from the HOME screen:

**1 (Controlling sensor):** This line shows the reading from the loop supply or steam header sensor, depending upon the option set (option 2.0). If the loop supply or steam header sensor reading is invalid, this line will indicate that, and the system automatically set all the virtual HAND-OFF-AUTO switches to HAND mode.

**2 (Current setpoint):** This line shows the current setpoint as well as the source of that setpoint. If the system is disabled for any reason, this line as well as the SYSTEM LOAD line will indicate that the system is off as well as the reason why the system is off.



**3 (System load):** This line shows the current system load in percent. Note that this is the total system load and typically will not match the individual firing rates unless all units that are online are running. If the system is disabled for any reason, this line as well as the SYSTEM LOAD line will indicate that the system is off as well as the reason why the system is off.

**4 (Outdoor temperature):** This line shows the reading of the outdoor temperature sensor, if optioned (option group 2). If the outdoor temperature sensor reading is invalid, this line will indicate that, and the system will revert to using Setpoint 1 or Setpoint 2 (depends on status of *Use Setpoint 2* input).

**5 (Unit status):** This shows the current offline or online status of each unit.

OFFLINE	Unit is offline
STANDBY	Unit is online and commanded off
STARTING	Unit is online and is purging/starting
RUNNING	Unit is online and is running

**6 (lead/lag status):** This shows the current lead/lag status of each unit. If the unit is offline, this will show **N/A**. If online, this will show **LEAD** or **LAG 1... LAG 7**.

**7 (Firing rate bar graph):** If the unit is running, this shows the firing rate in bar graph form. This will be shown if the unit is offline and in local control mode or if the unit is online and commanded to run.

**8 (Pump status):** If pump use is enabled (option 4.0), the status of the pump will be shown. The status of the pump can be idle, running or alarm.

**9 (Virtual HAND-OFF-AUTO switches):** Touching the POWER icon will display the HAND-OFF-AUTO panel for the selected unit.

<b>HAND</b>	Unit will be offline and commanded to run using the local setpoint/sensor (independent).
<b>OFF</b>	Unit will be offline and commanded off.
<b>AUTO</b>	Unit will be online and commanded to run based on lead/lag settings.
<b>MANUAL</b>	This is only selectable while in HAND. Unit will be offline and commanded to run at the manual rate entered.

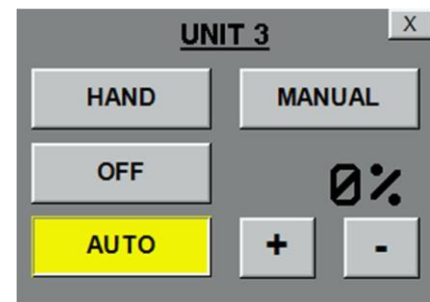

### Passcode

Passcodes are required to enter the SETUP screen and the SETPOINTS screen. +/- move the value by 1, ++/-- move the value by 10 and +++/-- move the value by 100.

The default passcode for the SETUP screen is 903. This can provide access to both the SETUP screen and SETPOINTS screen. The default passcode for the SETPOINTS screen is 154. This can be changed or disabled with an option (option 1.7, see *OPTIONS* section).

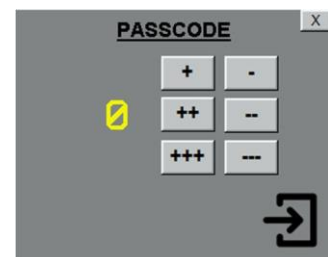

Once the passcode is entered, touch the ENTER icon to test the passcode. If correct, the SETUP or SETTINGS screen will be displayed. A user will remain logged in for 30 minutes every time the passcode is entered successfully.



## Setup

The SETUP screen shows all the option parameters. Navigation between the pages is possible using the PREVIOUS and NEXT icons.

Option Group 1 General	Option Group 2 Sensor	Option Group 3 Aux Input	Option Group 3 Pump
1.0 8	2.0 1	3.0 0	4.0 1
1.1 2.0	2.1 0	3.1 0	4.1 0
1.2 0	2.2 200	3.2 200	4.2 0
1.3 1			4.3 20
1.4 1			4.4 120
1.5 60			4.5 0
1.6 0			
1.7 154			

See the *OPTIONS* section for a full listing and description of all the option parameters.

The current status of the timers can be viewed by touching the *TIMER* icon.



## Timer Status

Timer Status Start Lead/Lag Timers		Timer Status Stop Lead/Lag Timers		Timer Status Pump Timers		Timer Status Unit Start Timers	
T1	0	T9	60	T17	120	T25	0
T2	300	T10	60	T18	120	T26	0
T3	300	T11	60	T19	120	T27	15
T4	300	T12	60	T20	120	T28	15
T5	300	T13	60	T21	120	T29	15
T6	300	T14	60	T22	120	T30	15
T7	300	T15	60	T23	120	T31	15
T8	3	T16	5	T24	120	T32	15

See the *TIMER STATUS* section for a full listing and description of all the timer functions.





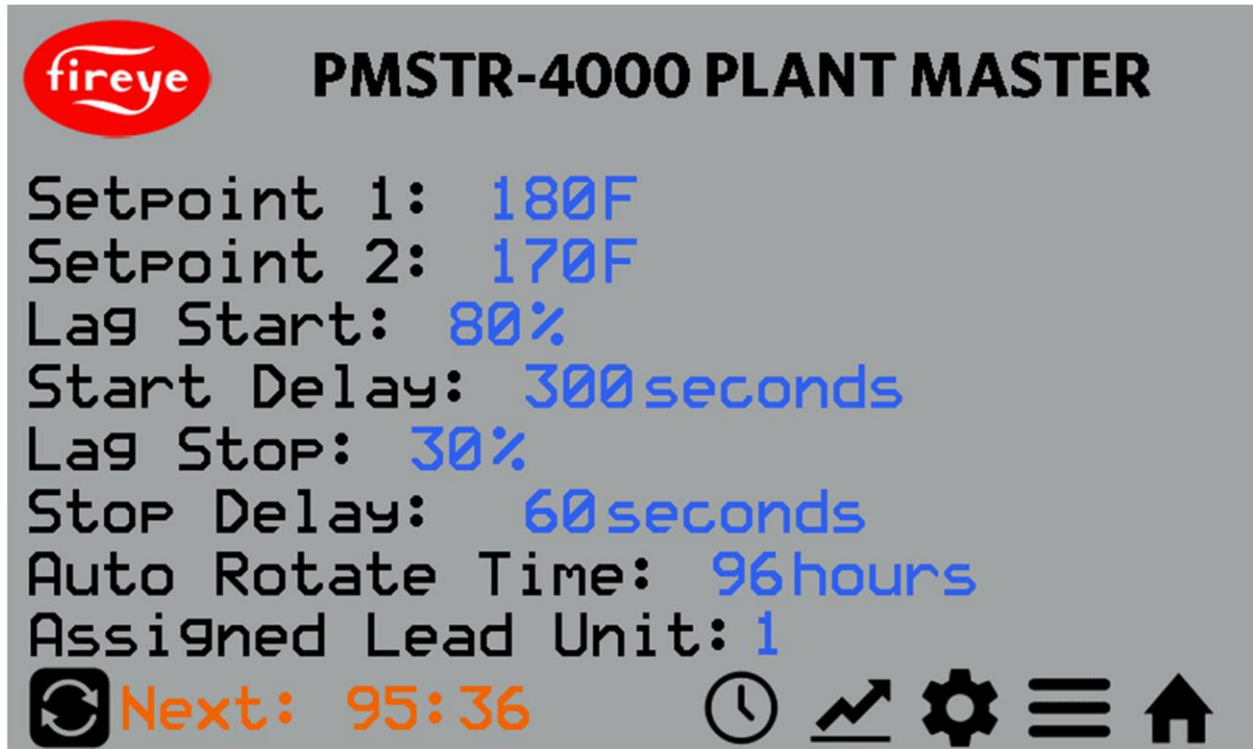

## Setpoints

The SETPOINTS screen shows all the operating parameters.



**PMSTR-4000 PLANT MASTER**

Setpoint 1: 180F  
Setpoint 2: 170F  
Lag Start: 80%  
Start Delay: 300seconds  
Lag Stop: 30%  
Stop Delay: 60seconds  
Auto Rotate Time: 96hours  
Assigned Lead Unit: 1

 Next: 95:36     

**SETPOINT 1:** Setpoint 1 can be set here. The valid range is the same as the sensor scaling.

**SETPOINT 2:** Setpoint 2 can be set here. The valid range is the same as the sensor scaling.

**LAG START:** This sets the percent of previous unit firing rate that must be exceeded before bringing on the next lag unit.

**START DELAY:** This sets the duration that the lag start percentage must be exceeded before bringing on the next lag unit.

**LAG STOP:** This sets the threshold of unit firing rate that must be exceeded to keep the lag unit enabled.

**STOP DELAY:** This sets the duration that the unit firing rate must be below the lag stop percentage before disabling the lag unit.

**AUTO ROTATE TIME:** This is the amount of run time in hours that the lead unit must run before automatic rotation makes the first lag the new lead unit.

**ASSIGNED LEAD UNIT:** This sets the assigned lead unit. This can be changed manually as desired.

**NEXT:** This shows the time in hours and minutes that remain until automatic rotation will occur. The RESET icon can be touched to reset this counter back to the setpoint for automatic rotation.

The CLOCK icon can be touched to bring up the panel to set the real-time clock.



## Setting Real-Time Clock

The real-time clock is used for timestamping trend graph entries as well as for time-of-day schedule use. The hours are always in a 24-hour format and any changes will take effect immediately.

The date format shown on the HOME screen can be shown in either MM/DD/YYYY or DD/MM/YYYY format by changing an option parameter. See *OPTIONS* section for additional detail.

MM:	3	+	-
DD:	7	+	-
YY:	21	+	-
hh:	22	+	-
mm:	34	+	-

## Trend

The TREND screen shows a historical trend comparing the loop supply or steam header to the system setpoint. The entries are marked with a time stamp.

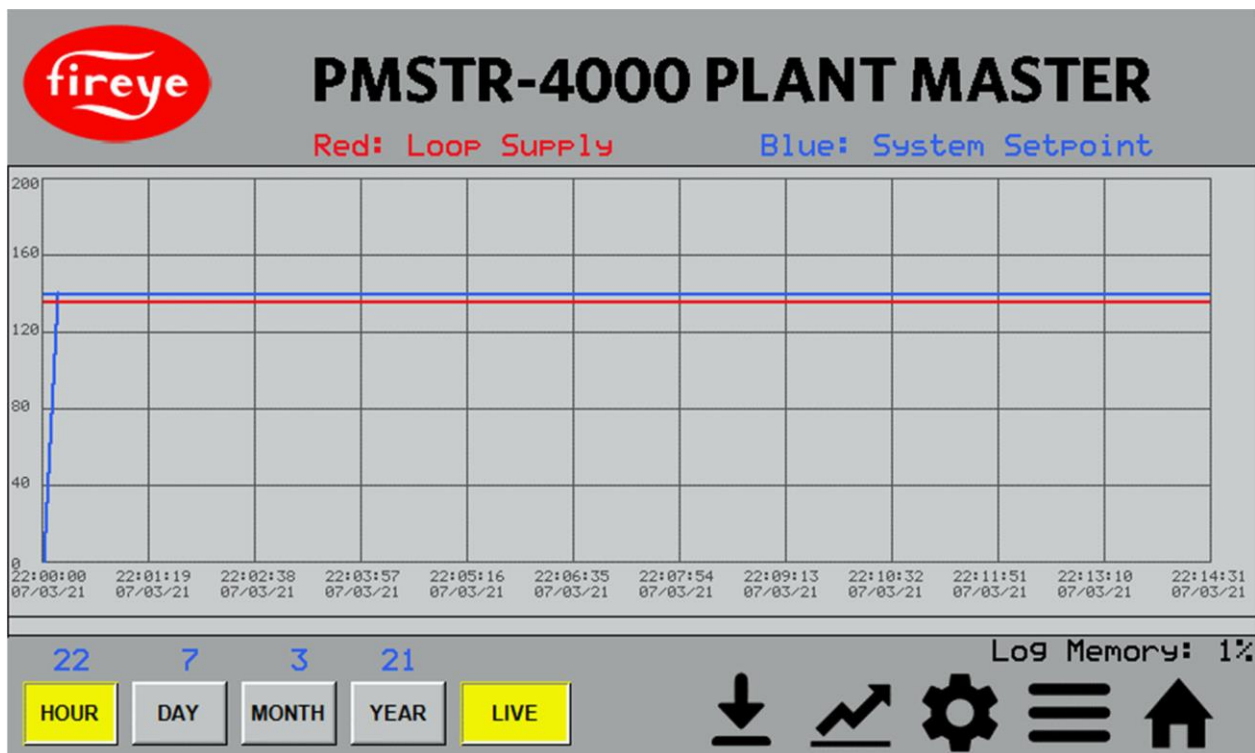

**HOUR/DAY/MONTH/YEAR:** View the hour/day/month/year shown for the date entered in blue (above the HOUR/DAY/MONTH/YEAR buttons).

**LIVE:** View new entries live as they write to memory.

**LOG MEMORY:** Shows how much logging memory is occupied. There is an option parameter available to reset the memory (option 12.1, see *OPTIONS* section). Without resetting, the newest data will overwrite the oldest data if the memory is full.

**DOWNLOAD LOG:** Touch the DOWNLOAD icon to save the log contents to USB. The current status of the USB write operation will be shown to the left of the icon. Do not remove the icon until writing is complete. Note that downloading may take a while to complete, with a longer selected span taking longer.





## Data Log

While the TREND screen only shows the loop supply or steam header against the system setpoint, the PMSTR-4000 data logs 23 different points every 10 seconds.

These are the points that are logged:

- Process\_Variable
- System\_Setpoint
- Assigned\_Lead
- Actual\_Lead
- Units\_Online
- Units\_Running
- Unit\_1\_Run
- Unit\_1\_Rate
- Unit\_2\_Run
- Unit\_2\_Rate
- Unit\_3\_Run
- Unit\_3\_Rate
- Unit\_4\_Run
- Unit\_4\_Rate
- Unit\_5\_Run
- Unit\_5\_Rate
- Unit\_6\_Run
- Unit\_6\_Rate
- Unit\_7\_Run
- Unit\_7\_Rate
- Unit\_8\_Run
- Unit\_8\_Rate

The download will be stored on the USB drive in the following path:

<drive letter>\HMC3070AM\PV-SP\_DL.CSV

The file name will be the same every time it is downloaded and will be overwritten if it already exists.

The format of the CSV file is as shown:

	A	B	C	D	E	F	G	H	I
1	DATE	TIME	Process_Variable	System_Setpoint	System_Load	Assigned_Lead	Actual_Lead	Units_Online	Units_Running
2									
3	9/3/2021	19:55:28	137	150	100	1	1	8	3
4	9/3/2021	19:55:38	137	150	100	1	1	8	3
5	9/3/2021	19:55:48	137	150	100	1	1	8	3
6	9/3/2021	19:55:58	137	150	100	1	1	8	3
7	9/3/2021	19:56:08	137	150	100	1	1	8	3
8	9/3/2021	19:56:18	137	150	100	1	1	8	3
9	9/3/2021	19:56:28	137	150	100	1	1	8	3
10	9/3/2021	19:56:38	137	150	100	1	1	8	3
11	9/3/2021	19:56:48	137	150	100	1	1	8	3
12	9/3/2021	19:56:58	137	150	100	1	1	8	3
13	9/3/2021	19:57:08	137	150	100	1	1	8	3
14	9/3/2021	19:57:18	137	150	100	1	1	8	3
15	9/3/2021	19:57:28	137	150	100	1	1	8	3



## OPTION PARAMETERS

Option parameters are used to set up the PMSTR-4000. Options are collected in groups and described by the group number and then the option number (i.e., option 2.1).

### Option Group 1 – General

Option	Description	Min	Max	Default	Notes
1.0	Total units connected to PMSTR-4000	1	8	2	How many units to lead/lag.
1.1	Software revision (format = X.Y)	---	---	---	Read only indication of PMSTR-4000 software revision.
1.2	Option code	0	999	0	Reserved.
1.3	Screen beep control	0	1	1	Enable/disable screen beep.
1.4	Screen saver control	0	1	1	Enable/disable screen saver.
1.5	Screen saver timer	0	999	60	Screen saver delay in minutes when enabled.
1.6	Date/time format	0	1	0	Date/time format. 0 = MM/DD/YYYY 1 = DD/MM/YYYY
1.7	Setpoint screen passcode	0	999	0	Setpoint screen passcode from 000-999. Setting to 000 disables passcode requirement.

### Option Group 2 – Sensor

Option	Description	Min	Max	Default	Notes
2.0	Type of system	0	3	3	Assignment for display units. 0 = °C 1 = °F 2 = mBar 3 = psi
2.1	PV input low scale	0	9999	0	Sensor low scale.
2.2	PV input high scale	0	9999	200	Sensor high scale.

### Option Group 3 – Aux Input

Option	Description	Min	Max	Default	Notes
3.0	Aux input use	0	1	1	Assignment for aux input. 0 = outdoor temperature sensor 1 = remote setpoint
3.1	Aux input low scale	-999	999	0	Aux input low scale.
3.2	Aux input high scale	0	9999	200	Aux input high scale.



### Option Group 4 – Pump

Option	Description	Min	Max	Default	Notes
4.0	Use pump	0	1	0	Enable pump outputs.
4.1	Use pump alarms	0	1	0	Create pump alarms if operation not proven in time.
4.2	Lead unit pump will run continuously	0	1	0	Pump for lead unit runs continuously.
4.3	Time for pump to prove before alarm	0	9999	20	Time for pump to prove before alarm, in seconds.
4.4	Pump off delay time after unit is disabled	0	9999	120	Time pump will remain enabled after unit disabled.
4.5	Pump output logic	0	1	0	Polarity of outputs. 0 = output on when enabled 1 = output off when enabled

### Option Group 5 – Timers

Option	Description	Min	Max	Default	Notes
5.0	Unit start delay after pump starts on enable	0	999	15	Time unit will remain disabled following pump enable.
5.1	Unit delay before modulation	0	999	30	Delay after unit running before modulation allowed.
5.2	Time previous lead unit will overlap	0	999	3	How long former lead will remain enabled after lead changes.
5.3	Time of no load before lead is disabled	0	999	5	How long a no-load condition must last before lead is disabled.

### Option Group 6 – Outside Air

Option	Description	Min	Max	Default	Notes
6.0	Outdoor reset start temperature	-99	99	30	Lowest outside temperature in reset slope.
6.1	Outdoor reset design temperature	0	120	70	Highest outside temperature in reset slope.
6.2	Outdoor reset minimum reset	0	999	120	Lowest setpoint in reset slope.
6.3	Outdoor reset maximum reset	0	999	180	Highest setpoint in reset slope.
6.4	Outdoor temperature system shutdown	0	120	80	Temperature where system will become disabled.



### Option Group 7 – Setpoints

Option	Description	Min	Max	Default	Notes
7.0	Use setpoint 2 with priority	0	1	0	Setpoint 2 will have priority over all other setpoints.
7.1	Maximum units to run when setpoint 1 in use	1	8	2	Choose to limit total units allowed to run for setpoint 1.
7.2	Maximum units to run when setpoint 2 in use	1	8	2	Choose to limit total units allowed to run for setpoint 2.
7.3	Proportional band for PID	0	999	10	Proportional band for PID algorithm in PV units.
7.4	Integral time for PID	0	999	60	Integral time for PID algorithm in seconds. 0 disables integral.
7.5	Derivative time for PID	0	999	0	Derivative time for PID algorithm in seconds. 0 disables derivative.

### Option Group 8 – Setpoint 1 Skips

Option	Description	Min	Max	Default	Notes
8.0	Skip unit 1 as lead when setpoint 1 in use	0	1	0	Skip unit 1 as lead when using setpoint 1.
8.1	Skip unit 2 as lead when setpoint 1 in use	0	1	0	Skip unit 2 as lead when using setpoint 1.
8.2	Skip unit 3 as lead when setpoint 1 in use	0	1	0	Skip unit 3 as lead when using setpoint 1.
8.3	Skip unit 4 as lead when setpoint 1 in use	0	1	0	Skip unit 4 as lead when using setpoint 1.
8.4	Skip unit 5 as lead when setpoint 1 in use	0	1	0	Skip unit 5 as lead when using setpoint 1.
8.5	Skip unit 6 as lead when setpoint 1 in use	0	1	0	Skip unit 6 as lead when using setpoint 1.
8.6	Skip unit 7 as lead when setpoint 1 in use	0	1	0	Skip unit 7 as lead when using setpoint 1.
8.7	Skip unit 8 as lead when setpoint 1 in use	0	1	0	Skip unit 8 as lead when using setpoint 1.



### Option Group 9 – Setpoint 2 Skips

Option	Description	Min	Max	Default	Notes
9.0	Skip unit 1 as lead when setpoint 2 in use	0	1	0	Skip unit 1 as lead when using setpoint 2.
9.1	Skip unit 2 as lead when setpoint 2 in use	0	1	0	Skip unit 2 as lead when using setpoint 2.
9.2	Skip unit 3 as lead when setpoint 2 in use	0	1	0	Skip unit 3 as lead when using setpoint 2.
9.3	Skip unit 4 as lead when setpoint 2 in use	0	1	0	Skip unit 4 as lead when using setpoint 2.
9.4	Skip unit 5 as lead when setpoint 2 in use	0	1	0	Skip unit 5 as lead when using setpoint 2.
9.5	Skip unit 6 as lead when setpoint 2 in use	0	1	0	Skip unit 6 as lead when using setpoint 2.
9.6	Skip unit 7 as lead when setpoint 2 in use	0	1	0	Skip unit 7 as lead when using setpoint 2.
9.7	Skip unit 8 as lead when setpoint 2 in use	0	1	0	Skip unit 8 as lead when using setpoint 2.

### Option Group 10 – Setpoint 1 Order

Option	Description	Min	Max	Default	Notes
10.0	Rotation order position 1 when setpoint 1 in use	1	8	1	Position 1 in rotation order when using setpoint 1.
10.1	Rotation order position 2 when setpoint 1 in use	1	8	2	Position 2 in rotation order when using setpoint 1.
10.2	Rotation order position 3 when setpoint 1 in use	1	8	3	Position 3 in rotation order when using setpoint 1.
10.3	Rotation order position 4 when setpoint 1 in use	1	8	4	Position 4 in rotation order when using setpoint 1.
10.4	Rotation order position 5 when setpoint 1 in use	1	8	5	Position 5 in rotation order when using setpoint 1.
10.5	Rotation order position 6 when setpoint 1 in use	1	8	6	Position 6 in rotation order when using setpoint 1.
10.6	Rotation order position 7 when setpoint 1 in use	1	8	7	Position 7 in rotation order when using setpoint 1.
10.7	Rotation order position 8 when setpoint 1 in use	1	8	8	Position 8 in rotation order when using setpoint 1.



### Option Group 11 – Setpoint 2 Order

Option	Description	Min	Max	Default	Notes
11.0	Rotation order position 1 when setpoint 2 in use	1	8	1	Position 1 in rotation order when using setpoint 2.
11.1	Rotation order position 2 when setpoint 2 in use	1	8	2	Position 2 in rotation order when using setpoint 2.
11.2	Rotation order position 3 when setpoint 2 in use	1	8	3	Position 3 in rotation order when using setpoint 2.
11.3	Rotation order position 4 when setpoint 2 in use	1	8	4	Position 4 in rotation order when using setpoint 2.
11.4	Rotation order position 5 when setpoint 2 in use	1	8	5	Position 5 in rotation order when using setpoint 2.
11.5	Rotation order position 6 when setpoint 2 in use	1	8	6	Position 6 in rotation order when using setpoint 2.
11.6	Rotation order position 7 when setpoint 2 in use	1	8	7	Position 7 in rotation order when using setpoint 2.
11.7	Rotation order position 8 when setpoint 2 in use	1	8	8	Position 8 in rotation order when using setpoint 2.

### Option Group 12 – Commands

Option	Description	Min	Max	Default	Notes
12.0	Applies all default values when set to 1	0	1	0	Set to 1 to apply defaults. Will automatically reset to 0.
12.1	Clear all data log memory when set to 1	0	1	0	Set to 1 to clear all data log memory. Will automatically reset to 0.

### Option Group 13 – Network IP Address

Option	Description	Min	Max	Default	Notes
13.0	IP address first byte	0	255	192	IP address first byte.
13.1	IP address second byte	0	255	168	IP address second byte.
13.2	IP address third byte	0	255	0	IP address third byte.
13.3	IP address fourth byte	0	255	11	IP address fourth byte.

### Option Group 14 – Network Subnet Mask

Option	Description	Min	Max	Default	Notes
14.0	Subnet mask first byte	0	255	255	Subnet mask first byte.
14.1	Subnet mask second byte	0	255	255	Subnet mask second byte.
14.2	Subnet mask third byte	0	255	255	Subnet mask third byte.
14.3	Subnet mask fourth byte	0	255	0	Subnet mask fourth byte.



### Option Group 15 – Network Default Gateway

Option	Description	Min	Max	Default	Notes
15.0	Default gateway first byte	0	255	0	Default gateway first byte.
15.1	Default gateway second byte	0	255	0	Default gateway second byte.
15.2	Default gateway third byte	0	255	0	Default gateway third byte.
15.3	Default gateway fourth byte	0	255	0	Default gateway fourth byte.

### Option Group 16 – Modbus RTU

Option	Description	Min	Max	Default	Notes
16.0	Modbus RTU server node address	1	255	1	Modbus RTU server node address.
16.1	Modbus RTU server baud rate	0	6	3	Modbus RTU server baud rate. 0 = 4800 1 = 9600 2 = 19200 3 = 38400 4 = 57600 5 = 115200 6 = 187500
16.2	Modbus RTU server data bits	0	1	1	Modbus RTU server data bits. 0 = 7 data bits 1 = 8 data bits
16.3	Modbus RTU server parity	0	2	0	Modbus RTU server parity. 0 = No parity 1 = even parity 2 = odd parity
16.4	Modbus RTU server stop bits	0	1	0	Modbus RTU server stop bits. 0 = 1 stop bit 1 = 2 stop bits



### Option Group 17 – Sunday Schedule

Option	Description	Min	Max	Default	Notes
17.0	Sunday schedule action in range	0	2	0	Sunday action between start and end times. 0 = Enabled using normal setpoint (no action) 1 = Enabled using setpoint 2 2 = System disabled
17.1	Sunday schedule start of range	0	23	8	Sunday start of range. Start hour must be earlier than end hour. Hours are in 24-hour format and start range is inclusive (start hour is in range).
17.2	Sunday schedule action outside of range	0	2	0	Sunday action outside of start and end times. 0 = Enabled using normal setpoint (no action) 1 = Enabled using setpoint 2 2 = System disabled
17.3	Sunday schedule end of range	0	23	17	Sunday end of range. End hour must be later than end hour. Hours are in 24-hour format and end range is inclusive (end hour is in range).

### Option Group 18 – Monday Schedule

Option	Description	Min	Max	Default	Notes
18.0	Monday schedule action in range	0	2	0	Monday action between start and end times. 0 = Enabled using normal setpoint (no action) 1 = Enabled using setpoint 2 2 = System disabled
18.1	Monday schedule start of range	0	23	8	Monday start of range. Start hour must be earlier than end hour. Hours are in 24-hour format and start range is inclusive (start hour is in range).
18.2	Monday schedule action outside of range	0	2	0	Monday action outside of start and end times. 0 = Enabled using normal setpoint (no action) 1 = Enabled using setpoint 2 2 = System disabled
18.3	Monday schedule end of range	0	23	17	Monday end of range. End hour must be later than end hour. Hours are in 24-hour format and end range is inclusive (end hour is in range).





### Option Group 19 – Tuesday Schedule

Option	Description	Min	Max	Default	Notes
19.0	Tuesday schedule action in range	0	2	0	Tuesday action between start and end times. 0 = Enabled using normal setpoint (no action) 1 = Enabled using setpoint 2 2 = System disabled
19.1	Tuesday schedule start of range	0	23	8	Tuesday start of range. Start hour must be earlier than end hour. Hours are in 24-hour format and start range is inclusive (start hour is in range).
19.2	Tuesday schedule action outside of range	0	2	0	Tuesday action outside of start and end times. 0 = Enabled using normal setpoint (no action) 1 = Enabled using setpoint 2 2 = System disabled
19.3	Tuesday schedule end of range	0	23	17	Tuesday end of range. End hour must be later than end hour. Hours are in 24-hour format and end range is inclusive (end hour is in range).

### Option Group 20 – Wednesday Schedule

Option	Description	Min	Max	Default	Notes
20.0	Wednesday schedule action in range	0	2	0	Wednesday action between start and end times. 0 = Enabled using normal setpoint (no action) 1 = Enabled using setpoint 2 2 = System disabled
20.1	Wednesday schedule start of range	0	23	8	Wednesday start of range. Start hour must be earlier than end hour. Hours are in 24-hour format and start range is inclusive (start hour is in range).
20.2	Wednesday schedule action outside of range	0	2	0	Wednesday action outside of start and end times. 0 = Enabled using normal setpoint (no action) 1 = Enabled using setpoint 2 2 = System disabled
20.3	Wednesday schedule end of range	0	23	17	Wednesday end of range. End hour must be later than end hour. Hours are in 24-hour format and end range is inclusive (end hour is in range).



### Option Group 21 – Thursday Schedule

Option	Description	Min	Max	Default	Notes
21	Thursday schedule action in range	0	2	0	Thursday action between start and end times. 0 = Enabled using normal setpoint (no action) 1 = Enabled using setpoint 2 2 = System disabled
21.1	Thursday schedule start of range	0	23	8	Thursday start of range. Start hour must be earlier than end hour. Hours are in 24-hour format and start range is inclusive (start hour is in range).
21.2	Thursday schedule action outside of range	0	2	0	Thursday action outside of start and end times. 0 = Enabled using normal setpoint (no action) 1 = Enabled using setpoint 2 2 = System disabled
21.3	Thursday schedule end of range	0	23	17	Thursday end of range. End hour must be later than end hour. Hours are in 24-hour format and end range is inclusive (end hour is in range).

### Option Group 22 – Friday Schedule

Option	Description	Min	Max	Default	Notes
22.0	Friday schedule action in range	0	2	0	Friday action between start and end times. 0 = Enabled using normal setpoint (no action) 1 = Enabled using setpoint 2 2 = System disabled
22.1	Friday schedule start of range	0	23	8	Friday start of range. Start hour must be earlier than end hour. Hours are in 24-hour format and start range is inclusive (start hour is in range).
22.2	Friday schedule action outside of range	0	2	0	Friday action outside of start and end times. 0 = Enabled using normal setpoint (no action) 1 = Enabled using setpoint 2 2 = System disabled
22.3	Friday schedule end of range	0	23	17	Friday end of range. End hour must be later than end hour. Hours are in 24-hour format and end range is inclusive (end hour is in range).



### Option Group 23 – Saturday Schedule

Option	Description	Min	Max	Default	Notes
23.0	Saturday schedule action in range	0	2	0	Saturday action between start and end times. 0 = Enabled using normal setpoint (no action) 1 = Enabled using setpoint 2 2 = System disabled
23.1	Saturday schedule start of range	0	23	8	Saturday start of range. Start hour must be earlier than end hour. Hours are in 24-hour format and start range is inclusive (start hour is in range).
23.2	Saturday schedule action outside of range	0	2	0	Saturday action outside of start and end times. 0 = Enabled using normal setpoint (no action) 1 = Enabled using setpoint 2 2 = System disabled
23.3	Saturday schedule end of range	0	23	17	Saturday end of range. End hour must be later than end hour. Hours are in 24-hour format and end range is inclusive (end hour is in range).



## TIMER STATUS

Option parameters are used to set up the PMSTR-4000. Options are collected in groups and described by the group.

Timer	Description	Notes
T1	Start timer lag 1	Shows time remaining for the start timer for lag 1. Counts down from setpoint while timing and stays at zero when lag is enabled.
T2	Start timer lag 2	Shows time remaining for the start timer for lag 2. Counts down from setpoint while timing and stays at zero when lag is enabled.
T3	Start timer lag 3	Shows time remaining for the start timer for lag 3. Counts down from setpoint while timing and stays at zero when lag is enabled.
T4	Start timer lag 4	Shows time remaining for the start timer for lag 4. Counts down from setpoint while timing and stays at zero when lag is enabled.
T5	Start timer lag 5	Shows time remaining for the start timer for lag 5. Counts down from setpoint while timing and stays at zero when lag is enabled.
T6	Start timer lag 6	Shows time remaining for the start timer for lag 6. Counts down from setpoint while timing and stays at zero when lag is enabled.
T7	Start timer lag 7	Shows time remaining for the start timer for lag 7. Counts down from setpoint while timing and stays at zero when lag is enabled.
T8	Lead change overlap timer	Shows time remaining for the overlap when former lead runs after a lead change. Counts down from setpoint while timing and resets to setpoint when finished timing.
T9	Stop timer lag 1	Shows time remaining for the stop timer for lag 1. Counts down from setpoint while timing and resets to setpoint when finished timing.
T10	Stop timer lag 2	Shows time remaining for the stop timer for lag 2. Counts down from setpoint while timing and resets to setpoint when finished timing.
T11	Stop timer lag 3	Shows time remaining for the stop timer for lag 3. Counts down from setpoint while timing and resets to setpoint when finished timing.
T12	Stop timer lag 4	Shows time remaining for the stop timer for lag 4. Counts down from setpoint while timing and resets to setpoint when finished timing.
T13	Stop timer lag 5	Shows time remaining for the stop timer for lag 5. Counts down from setpoint while timing and resets to setpoint when finished timing.
T14	Stop timer lag 6	Shows time remaining for the stop timer for lag 6. Counts down from setpoint while timing and resets to setpoint when finished timing.
T15	Stop timer lag 7	Shows time remaining for the stop timer for lag 7. Counts down from setpoint while timing and resets to setpoint when finished timing.
T16	No load shutdown timer	Shows time remaining to shut off all units when load demand is at zero. Counts down from setpoint while timing and resets to setpoint when finished timing.
T17	Pump off delay timer unit 1	Shows time remaining for pump off delay for unit 1. Applies only when pump is enabled. Counts down from setpoint while timing and resets to setpoint when finished timing.
T18	Pump off delay timer unit 2	Shows time remaining for pump off delay for unit 2. Applies only when pump is enabled. Counts down from setpoint while timing and resets to setpoint when finished timing.
T19	Pump off delay timer unit 3	Shows time remaining for pump off delay for unit 3. Applies only when pump is enabled. Counts down from setpoint while timing and resets to setpoint when finished timing.
T20	Pump off delay timer unit 4	Shows time remaining for pump off delay for unit 4. Applies only when pump is enabled. Counts down from setpoint while timing and resets to setpoint when finished timing.



Timer	Description	Notes
T21	Pump off delay timer unit 5	Shows time remaining for pump off delay for unit 5. Applies only when pump is enabled. Counts down from setpoint while timing and resets to setpoint when finished timing.
T22	Pump off delay timer unit 6	Shows time remaining for pump off delay for unit 6. Applies only when pump is enabled. Counts down from setpoint while timing and resets to setpoint when finished timing.
T23	Pump off delay timer unit 7	Shows time remaining for pump off delay for unit 7. Applies only when pump is enabled. Counts down from setpoint while timing and resets to setpoint when finished timing.
T24	Pump off delay timer unit 8	Shows time remaining for pump off delay for unit 8. Applies only when pump is enabled. Counts down from setpoint while timing and resets to setpoint when finished timing.
T25	Start delay timer unit 1	Shows time remaining for the start delay timer for unit 1. Applies only when pump is enabled. Counts down from setpoint while timing and stays at zero when unit is enabled.
T26	Start delay timer unit 2	Shows time remaining for the start delay timer for unit 2. Applies only when pump is enabled. Counts down from setpoint while timing and stays at zero when unit is enabled.
T27	Start delay timer unit 3	Shows time remaining for the start delay timer for unit 3. Applies only when pump is enabled. Counts down from setpoint while timing and stays at zero when unit is enabled.
T28	Start delay timer unit 4	Shows time remaining for the start delay timer for unit 4. Applies only when pump is enabled. Counts down from setpoint while timing and stays at zero when unit is enabled.
T29	Start delay timer unit 5	Shows time remaining for the start delay timer for unit 5. Applies only when pump is enabled. Counts down from setpoint while timing and stays at zero when unit is enabled.
T30	Start delay timer unit 6	Shows time remaining for the start delay timer for unit 6. Applies only when pump is enabled. Counts down from setpoint while timing and stays at zero when unit is enabled.
T31	Start delay timer unit 7	Shows time remaining for the start delay timer for unit 7. Applies only when pump is enabled. Counts down from setpoint while timing and stays at zero when unit is enabled.
T32	Start delay timer unit 8	Shows time remaining for the start delay timer for unit 8. Applies only when pump is enabled. Counts down from setpoint while timing and stays at zero when unit is enabled.

## MODBUS

Modbus is available in either a TCP/IP connection or an RTU connection. The mapping is the same for each – see the MODBUS MAPPING section for a complete list.

Modbus data is contained in holding registers (4x type) and coil registers (0x type). Use function code 3 to read the holding registers and function code 1 to read the coil registers. Any writes to data can use either function code 6 or function code 16. The valid holding register area is from 40001 to 40059, and the valid coil register area is from 00001 to 00089. Any reads/writes must begin and end in this range. There is no limit from the server side as to how many registers can be read consecutively.

### Modbus Connection

The Modbus TCP/IP connection uses standard Cat5 cabling and Ethernet topology. If the connection is made directly to another device, automatic switching will take place, so a crossover cable is not required. Make sure that the IP address is not duplicated, or a pop-up window will appear to allow the IP address to be changed. Note that this pop-up is automatic and will allow DHCP to be selected. Do not select DHCP as doing so may make it difficult to locate the device on the network.

The Modbus RTU connection is made to the DB9 female connector on COM2. This connector supports RS232, RS422 or RS485. A custom cable can be made or a connector such as the DGB9MT1 from L-Com can be used to convert to terminals (image shown).

DB connectors have standard pin numbers from 1 to 9. These are shown in the table below with the corresponding functions:

DB9 Pin	Function
1	RS422/RS485 Tx+
2	RS232 Transmit
3	RS232 Receive
4	RS422/RS485 Rx+
5	Ground
6	No connection
7	No connection
8	RS422/RS485 Tx-
9	RS422/RS485 Tx-



*L-Com DGB9MT1*

Connection diagrams:

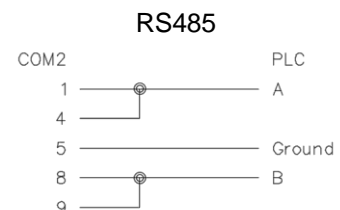
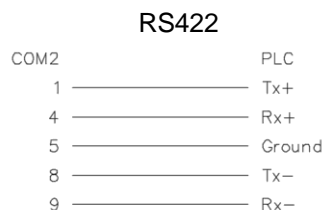
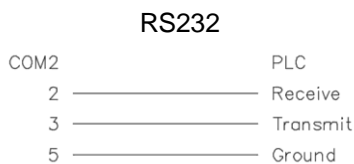



## Modbus Mapping

Read access is shown with **R** and write access is shown with **W**.

Data types:

- **UINT** (unsigned integers, occupies a single register)
- **SINT** (signed integers, occupies a single register)
- **BOOL** (single bit)

Address	Description	Access	Type	Bounds Low	Bounds High	Default
00001	Remote disable	RW	BOOL	---	---	---
00002	Use setpoint 2	RW	BOOL	---	---	---
00003	Reset auto rotate time	RW	BOOL	---	---	---
00004	spare	RW	BOOL	---	---	---
00005	spare	RW	BOOL	---	---	---
00006	spare	RW	BOOL	---	---	---
00007	spare	RW	BOOL	---	---	---
00008	spare	RW	BOOL	---	---	---
00009	spare	RW	BOOL	---	---	---
00010	Use manual fire rate when in hand unit 1	RW	BOOL	---	---	---
00011	Use manual fire rate when in hand unit 2	RW	BOOL	---	---	---
00012	Use manual fire rate when in hand unit 3	RW	BOOL	---	---	---
00013	Use manual fire rate when in hand unit 4	RW	BOOL	---	---	---
00014	Use manual fire rate when in hand unit 5	RW	BOOL	---	---	---
00015	Use manual fire rate when in hand unit 6	RW	BOOL	---	---	---
00016	Use manual fire rate when in hand unit 7	RW	BOOL	---	---	---
00017	Use manual fire rate when in hand unit 8	RW	BOOL	---	---	---
00018	spare	RW	BOOL	---	---	---
00019	spare	RW	BOOL	---	---	---
00020	Communication good unit 1	R	BOOL	---	---	---
00021	Communication good unit 2	R	BOOL	---	---	---
00022	Communication good unit 3	R	BOOL	---	---	---
00023	Communication good unit 4	R	BOOL	---	---	---
00024	Communication good unit 5	R	BOOL	---	---	---
00025	Communication good unit 6	R	BOOL	---	---	---
00026	Communication good unit 7	R	BOOL	---	---	---
00027	Communication good unit 8	R	BOOL	---	---	---
00028	spare	RW	BOOL	---	---	---
00029	spare	RW	BOOL	---	---	---
00030	Enable when in auto unit 1	R	BOOL	---	---	---
00031	Enable when in auto unit 2	R	BOOL	---	---	---
00032	Enable when in auto unit 3	R	BOOL	---	---	---
00033	Enable when in auto unit 4	R	BOOL	---	---	---
00034	Enable when in auto unit 5	R	BOOL	---	---	---
00035	Enable when in auto unit 6	R	BOOL	---	---	---
00036	Enable when in auto unit 7	R	BOOL	---	---	---
00037	Enable when in auto unit 8	R	BOOL	---	---	---
00038	spare	RW	BOOL	---	---	---
00039	spare	RW	BOOL	---	---	---
00040	Running unit 1	R	BOOL	---	---	---



Address	Description	Access	Type	Bounds Low	Bounds High	Default
00041	Running unit 2	R	BOOL	---	---	---
00042	Running unit 3	R	BOOL	---	---	---
00043	Running unit 4	R	BOOL	---	---	---
00044	Running unit 5	R	BOOL	---	---	---
00045	Running unit 6	R	BOOL	---	---	---
00046	Running unit 7	R	BOOL	---	---	---
00047	Running unit 8	R	BOOL	---	---	---
00048	spare	RW	BOOL	---	---	---
00049	spare	RW	BOOL	---	---	---
00050	Enable in auto lead	R	BOOL	---	---	---
00051	Enable in auto lag 1	R	BOOL	---	---	---
00052	Enable in auto lag 2	R	BOOL	---	---	---
00053	Enable in auto lag 3	R	BOOL	---	---	---
00054	Enable in auto lag 4	R	BOOL	---	---	---
00055	Enable in auto lag 5	R	BOOL	---	---	---
00056	Enable in auto lag 6	R	BOOL	---	---	---
00057	Enable in auto lag 7	R	BOOL	---	---	---
00058	spare	RW	BOOL	---	---	---
00059	spare	RW	BOOL	---	---	---
00060	Pump enable unit 1	R	BOOL	---	---	---
00061	Pump enable unit 2	R	BOOL	---	---	---
00062	Pump enable unit 3	R	BOOL	---	---	---
00063	Pump enable unit 4	R	BOOL	---	---	---
00064	Pump enable unit 5	R	BOOL	---	---	---
00065	Pump enable unit 6	R	BOOL	---	---	---
00066	Pump enable unit 7	R	BOOL	---	---	---
00067	Pump enable unit 8	R	BOOL	---	---	---
00068	spare	RW	BOOL	---	---	---
00069	spare	RW	BOOL	---	---	---
00070	Pump proven unit 1	R	BOOL	---	---	---
00071	Pump proven unit 2	R	BOOL	---	---	---
00072	Pump proven unit 3	R	BOOL	---	---	---
00073	Pump proven unit 4	R	BOOL	---	---	---
00074	Pump proven unit 5	R	BOOL	---	---	---
00075	Pump proven unit 6	R	BOOL	---	---	---
00076	Pump proven unit 7	R	BOOL	---	---	---
00077	Pump proven unit 8	R	BOOL	---	---	---
00078	spare	RW	BOOL	---	---	---
00079	spare	RW	BOOL	---	---	---
00080	Pump alarm unit 1	R	BOOL	---	---	---
00081	Pump alarm unit 2	R	BOOL	---	---	---
00082	Pump alarm unit 3	R	BOOL	---	---	---
00083	Pump alarm unit 4	R	BOOL	---	---	---
00084	Pump alarm unit 5	R	BOOL	---	---	---
00085	Pump alarm unit 6	R	BOOL	---	---	---
00086	Pump alarm unit 7	R	BOOL	---	---	---
00087	Pump alarm unit 8	R	BOOL	---	---	---
00088	spare	RW	BOOL	---	---	---
00089	spare	RW	BOOL	---	---	---





Address	Description	Access	Type	Bounds Low	Bounds High	Default
40001	Loop supply or steam header (PV)	R	UINT	---	---	---
40002	Current active setpoint	R	UINT	---	---	---
40003	Setpoint 1	RW	UINT	0	PV high scale	---
40004	Setpoint 2	RW	UINT	0	PV high scale	---
40005	Remote setpoint	RW	UINT	0	PV high scale	---
40006	Source of setpoint (see note 1)	R	UINT	---	---	---
40007	Outdoor air temperature	R	SINT	---	---	---
40008	Current system load	R	UINT	---	---	---
40009	Assigned lead unit	RW	UINT	1	8	1
40010	Active lead unit	R	UINT	---	---	---
40011	Auto rotation hours (0 to disable rotation)	RW	UINT	0	999	96
40012	Auto rotation hours until next	R	UINT	---	---	---
40013	Auto rotation minutes until next	R	UINT	---	---	---
40014	Total units online	R	UINT	---	---	---
40015	Total units running	R	UINT	---	---	---
40016	Lag start percent	RW	UINT	0	100	80
40017	Lag start delay timer	RW	UINT	0	9999	300
40018	Lag stop percent (must be less than start)	RW	UINT	0	100	30
40019	Lag stop delay timer	RW	UINT	0	9999	60
40020	Online status of unit 1 (see note 2)	R	UINT	---	---	---
40021	Online status of unit 2 (see note 2)	R	UINT	---	---	---
40022	Online status of unit 3 (see note 2)	R	UINT	---	---	---
40023	Online status of unit 4 (see note 2)	R	UINT	---	---	---
40024	Online status of unit 5 (see note 2)	R	UINT	---	---	---
40025	Online status of unit 6 (see note 2)	R	UINT	---	---	---
40026	Online status of unit 7 (see note 2)	R	UINT	---	---	---
40027	Online status of unit 8 (see note 2)	R	UINT	---	---	---
40028	spare	RW	UINT	0	65535	---
40029	spare	RW	UINT	0	65535	---
40030	Actual firing rate unit 1	R	UINT	---	---	---
40031	Actual firing rate unit 2	R	UINT	---	---	---
40032	Actual firing rate unit 3	R	UINT	---	---	---
40033	Actual firing rate unit 4	R	UINT	---	---	---
40034	Actual firing rate unit 5	R	UINT	---	---	---
40035	Actual firing rate unit 6	R	UINT	---	---	---
40036	Actual firing rate unit 7	R	UINT	---	---	---
40037	Actual firing rate unit 8	R	UINT	---	---	---
40038	spare	RW	UINT	0	65535	---
40039	spare	RW	UINT	0	65535	---
40040	Switch unit 1 (hand=0, off=1, auto=2)	RW	UINT	0	2	---
40041	Switch unit 2 (hand=0, off=1, auto=2)	RW	UINT	0	2	---
40042	Switch unit 3 (hand=0, off=1, auto=2)	RW	UINT	0	2	---
40043	Switch unit 4 (hand=0, off=1, auto=2)	RW	UINT	0	2	---
40044	Switch unit 5 (hand=0, off=1, auto=2)	RW	UINT	0	2	---
40045	Switch unit 6 (hand=0, off=1, auto=2)	RW	UINT	0	2	---
40046	Switch unit 7 (hand=0, off=1, auto=2)	RW	UINT	0	2	---



Address	Description	Access	Type	Bounds Low	Bounds High	Default
40047	Switch unit 8 (hand=0, off=1, auto=2)	RW	UINT	0	2	---
40048	spare	RW	UINT	0	65535	---
40049	spare	RW	UINT	0	65535	---
40050	Manual fire rate when in hand unit 1	RW	UINT	0	100	---
40051	Manual fire rate when in hand unit 2	RW	UINT	0	100	---
40052	Manual fire rate when in hand unit 3	RW	UINT	0	100	---
40053	Manual fire rate when in hand unit 4	RW	UINT	0	100	---
40054	Manual fire rate when in hand unit 5	RW	UINT	0	100	---
40055	Manual fire rate when in hand unit 6	RW	UINT	0	100	---
40056	Manual fire rate when in hand unit 7	RW	UINT	0	100	---
40057	Manual fire rate when in hand unit 8	RW	UINT	0	100	---
40058	spare	RW	UINT	0	65535	---
40059	spare	RW	UINT	0	65535	---

**Note 1:** Source of setpoint.

- **0:** Setpoint 1
- **1:** Setpoint 2
- **2:** Outdoor temperature reset
- **3:** Setpoint 1 due to outdoor temperature sensor reading invalid
- **4:** Setpoint 2 due to outdoor temperature sensor reading invalid
- **5:** Remote setpoint via analog input
- **6:** Remote setpoint via Modbus
- **7:** System off due to no load
- **8:** System off due to warm weather shutdown
- **9:** System off due to no units online
- **10:** System off due to schedule command

**Note 2:** Online status of units.

- **0:** Offline due to configuration state, lockout, or open limits
- **1:** Offline due to not being in AUTO mode
- **2:** Offline due to local burner control or limit or pump alarm
- **3:** Online



---

## CERTIFICATIONS

UL508A Enclosed Industrial Control Panel (United States/Canada)



---

**NOTICE**

When Fireeye products are combined with equipment manufactured by others and/or integrated into systems designed or manufactured by others, the Fireeye warranty, as stated in its General Terms & Conditions of Sale, pertains only to the Fireeye products and not to any other equipment or to the combined system or its overall performance.

---

**WARRANTIES, EXCLUSIVE REMEDIES, AND LIMITATION OF DAMAGES**

Fireeye guarantees for one year from the date of installation or 18 months from the date of manufacture, whichever occurs first, to replace, or at its option, to repair any product or part thereof which Fireeye, in its sole discretion, deems to be defective in material or workmanship or which otherwise fails to conform to the description of the product on the face of its sales order. Fireeye's obligations pursuant to this warranty do not extend to any products or parts thereof which Fireeye determines to have been installed, operated, maintained, repaired, or altered improperly or otherwise than in conformity to Fireeye's applicable instructions, or which have been subject to misuse, accident, or neglect.

**THE FOREGOING IS IN LIEU OF ALL OTHER WARRANTIES, BOTH EXPRESS AND IMPLIED, INCLUDING THE WARRANTIES OF MERCHANTABILITY AND FITNESS FOR A PARTICULAR PURPOSE. EXCEPT AS SPECIFICALLY STATED IN THESE TERMS AND CONDITIONS OF SALE, REMEDIES WITH RESPECT TO ANY PRODUCT OR PART MANUFACTURED OR SOLD BY FIREYE, OR WITH RESPECT TO ANY BREACH OF OR DEFAULT UNDER THIS CONTRACT (INCLUDING ANY BREACH OF WARRANTY), SHALL BE LIMITED EXCLUSIVELY TO THE RIGHT TO REPLACEMENT OR REPAIR F.O.B. FIREYE MAIN WAREHOUSE LOCATION, AS ABOVE PROVIDED. IN NO EVENT SHALL FIREYE BE LIABLE FOR CONSEQUENTIAL OR SPECIAL DAMAGES OF ANY NATURE WHICH MAY ARISE IN CONNECTION WITH SUCH PRODUCT OR PART OR ANY BREACH OF OR DEFAULT UNDER THIS CONTRACT. TO THE EXTENT PERMITTED BY LAW, THE AGGREGATE LIABILITY OF FIREYE HEREUNDER WHETHER IN CONTRACT, TORT (INCLUDING NEGLIGENCE) OR OTHERWISE, WILL BE LIMITED TO ONE TIMES THE CONTRACT VALUE, PROVIDED HOWEVER THE FOREGOING LIMITATION DOES NOT LIMIT THE LIABILITY OF FIREYE FOR ANY INJURY TO, OR DEATH OF A PERSON, CAUSED BY THE GROSS NEGLIGENCE OF FIREYE.**